

CAMPIONATO ITALIANO JUNIORES SL



TERRASINI - PALERMO (ITA)

2013-05-11 - 2013-05-11 2013

Résultats - Results

Lutte Libre - Free-Style





Liste des arbitres / Referee list

CAMPIONATO ITALIANO JUNIORES SL

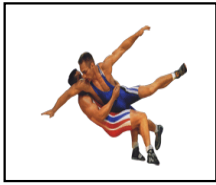

<i>N°</i>	<i>Licence</i>	<i>Pays Country</i>	<i>Nom - Last Name</i>	<i>Prénom - First Name</i>
-----------	----------------	-------------------------	------------------------	----------------------------

**Liste des nations / Countries List****CAMPIONATO ITALIANO JUNIORES SL****STYLE FS*****Pays - Country***

	03CO0085S.S.D. CLUB ATL	03CO0085
	PESANTE COMO	
	03MI0394 POL AFFORI MILANO	03MI0394
	04TN0240 LOTTA CLUB	
	ROVERETO	04TN0240
	04TN2712 ANCORVIS A.S.D.	04TN2712
	06PN2412 SAN GIORGIO	
	FIGHTERS CAMP	06PN2412
	07GE0003 C.COLOMBO	
	GENOVA	07GE0003
	07GE0497 POL MANDRACCIO	
	GE	07GE0497
	07IM1526 OK CLUB JUDO e	
	JUJITSU IMPERIA	07IM1526
	09PI0673 G.S VVF M.BILLI-S.	
	MASI PISA	09PI0673
	10PG0291 JUDO KODOKAN S.	
	SPELLO	10PG0291
	10PG0458 A S D PORTA SOLE	
	CULTURALE S	10PG0458
	10TR0030 P.D.CIRCOLO	
	LAVORATORI TERNI	10TR0030
	12RM0061 G.S. FIAMME ORO	12RM0061
	12RM0449 WELLNESS CLUB	12RM0449
	12RM1302 G.S. VV.F. SORGINI	
	ROMA	12RM1302
	15NA0201 CIRCOLO ILVA	
	BAGNOLI	15NA0201
	15NA2737 WRESTLING LIUZZI	15NA2737
	16BA0824 MEETING SPORT	
	BARI	16BA0824
	16BR1286 A.S.D. JUDO SAN	
	VITO	16BR1286
	18RC0022 ASD SGS	
	FORTITUDO1903 RC	18RC0022
	18RC0111 G.S. VV F REGGIO	
	CALABRIA	18RC0111
	18RC1303 A S SAN GIORGIO	
	RC	18RC1303
	19CT2677 MEETING GIARRE	
	A.S.D.	19CT2677
	19CT2971 ASD WRESTLING	
	SCORDIA CT	19CT2971
	19PA0058 ACC ATL PESANTE	
	SCUDERI	19PA0058
	19PA0078 C A S D TERMINI	
	IMERESE	19PA0078







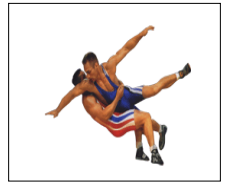

Liste des nations / Countries List

CAMPIONATO ITALIANO JUNIORES SL

STYLE FS



	19PA0177 A.S.CLUB MEDITERRANEO PALERMO	19PA0177
	19PA0411 ASD CLUB EDERA PALERMO	19PA0411
	19PA0639 G. S. D. LOTTA TERMINI IMERESE	19PA0639
	19PA0676 CLUB ATLETICO I PICCIOTTI A.S.D.	19PA0676
	19PA0993 G.S. VVF CARAMANNA PALERMO	19PA0993
	19PA1543 ASD LOTTA CLUB PALERMO	19PA1543
	20SS0992 POL ATHLON SASSARI 1988 ASD	20SS0992

Nombre de nations - Number of Countries



Nombre d'engagés par nation / Number of Entries By Country

CAMPIONATO ITALIANO JUNIORES SL

STYLE FS



<i>Pays - Country</i>	<i>120 KG</i>	<i>50 KG</i>	<i>55 KG</i>	<i>60 KG</i>	<i>66 KG</i>	<i>74 KG</i>	<i>84 KG</i>	<i>96 KG</i>	<i>TOTAL</i>
3CO0085						1	2		3
3MI0394				1	1				2
4TN0240				1		2			3
4TN2712	1								1
6PN2412								1	1
7GE0003			1		1	1	1		4
7GE0497			2			4	1		7
7IM1526				1					1
9PI0673						1	1		2
0PG0291				1		1	1		3
0PG0458					1				1
0TR0030						2			2
2RM0061	1				1	2			4
2RM0449						1	2		3
2RM1302						2			2
5NA0201				2	1				3
5NA2737			1		1				2
6BA0824			1						1
6BR1286		2			1	1	1		5
8RC0022			1					1	2
8RC0111	1	1	1		1	2	1	1	8
8RC1303					2	1			3
9CT2677					3	1			4
9CT2971				1					1
9PA0058	1	1		1	1		1	1	6
9PA0078		1	1	1	1	1	1		6
9PA0177			1			3	1	1	6
9PA0411	2		1			1		2	6
9PA0639		1	1	2	1		1	1	7
9PA0676	1			1		2		2	6
9PA0993			1	1				1	3
9PA1543					1				1
0SS0992						1			1



Nombre d'engagés par nation / Number of Entries By Country

CAMPIONATO ITALIANO JUNIORES SL

STYLE FS



<i>Pays - Country</i>	<i>120 KG</i>	<i>50 KG</i>	<i>55 KG</i>	<i>60 KG</i>	<i>66 KG</i>	<i>74 KG</i>	<i>84 KG</i>	<i>96 KG</i>	<i>TOTAL</i>
TOTAL	7	6	12	13	17	30	14	11	110

Nombre de nations - Number of Countries **33**



Liste des Engagés par pays / Entry-List By Country

CAMPIONATO ITALIANO JUNIORES SL

STYLE FS

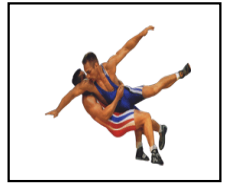

ITALY (ITA)

Lutteur(s) / Wrestler(s) :

03CO0085

74 kg PETRUK, Volodymyr

84 kg MOAZ, Zakaria
OUERGHI, Khalil

03MI0394

60 kg QUINAMI, Rampo

66 kg GUMBERIDZE, Aleksandre

04TN0240

60 kg KERTUSHA, Enio

74 kg ENDRIZZI, Giuseppe
GALVAGNI, Giacomo

04TN2712

120 kg RAZZINO, Gabriele

06PN2412

96 kg CHEMELLO, Loris

07GE0003

55 kg ALATI, Marco

66 kg TROIANI, Marco

74 kg PREJBAN, Liviu

84 kg CARCEA, Marco

07GE0497

55 kg MANSOUR, Abdellatif
MEMMA, Luca corrado

74 kg CANEVA, Aron
COMBERTI, Davide
TOFFANINI, Vendel
TORTOROLO, Alessio

84 kg SANTAMARIA, Francesco

07IM1526

60 kg MARTINI, Giacomo

09PI0673

74 kg JEBALI, Josepe

84 kg PAVLICHENKO, Mark

10PG0291

60 kg BALZANA, Michael

74 kg MOSQUERA RUIZ, Lenin fernando

84 kg GRAMACCIONI, Giacomo

10PG0458

66 kg ANGHELESCU, Marian

10TR0030

74 kg BATTISTI, Annibale



Liste des Engagés par pays / Entry-List By Country

CAMPIONATO ITALIANO JUNIORES SL

STYLE FS

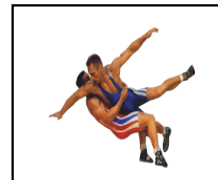

	ROSATI, Francesco
<u>12RM0061</u>	
120 kg	SWIRYDOWICZ, Janusz
66 kg	GUERRAZZI, Luca
74 kg	GIOVANNETTI, Giobbe giordan MANZARA, Francesco
<u>12RM0449</u>	
74 kg	AGRIGOROSOAEI, Sebastian Costel
84 kg	PIRVAN DORIN, Costantin RAFFI, William
<u>12RM1302</u>	
74 kg	MURRI, Andrea TRUNCALI, Matteo
<u>15NA0201</u>	
60 kg	CANGIANO, Alessandro TALAMO, Gianluca
66 kg	VARRELLA, Antonio giuseppe
<u>15NA2737</u>	
55 kg	DE GREGORIO, Girolamo
66 kg	CASABURI, Gaetano
<u>16BA0824</u>	
55 kg	HAZAN, Dylan
<u>16BR1286</u>	
50 kg	CASTRO, Giuseppe SARLENGA, Nunzio
66 kg	MELACCA, Gabriele
74 kg	TROMBACCA, Cosimo
84 kg	TAURISANO, Marco
<u>18RC0022</u>	
55 kg	ALAMPI, Emanuele
96 kg	BELLANTONIO, Domenico
<u>18RC0111</u>	
120 kg	MURNER, Marco
50 kg	SAPONE, Tiberio
55 kg	MARVICE, Ruben
66 kg	FERRARO, Giuseppe
74 kg	CANDIDO, Pietro MUSCIANESE, Beniamino
84 kg	ASSUMMA, Carmelo
96 kg	MALAVENDA, Natale
<u>18RC1303</u>	
66 kg	LABATE, Luca SPADARO, Marco
74 kg	CACCAMO, Michelangelo



Liste des Engagés par pays / Entry-List By Country

CAMPIONATO ITALIANO JUNIORES SL

STYLE FS

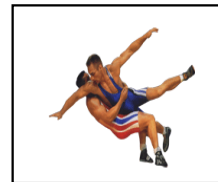

19CT2677

66 kg COCO, Gianluca
MESSINA, Alberto
VATTIATO, Francesco

74 kg MESSINA, Alessandro

19CT2971

60 kg PIZZIMENTO, Damiano

19PA0058

120 kg DAVI, Luigi
50 kg SORCE, Bruno
60 kg D'AMICO, Alessandro
66 kg FRAGASCIO, Luca
84 kg ONETO, Gabriele
96 kg MATTALIANO, Francesco

19PA0078

50 kg SOLDATINI, Giorgio
55 kg SCHILLACI, Marco
60 kg IANNOLINO, Vincenzo
66 kg MENDIETA, Giuseppe
74 kg BORDINO, Federico
84 kg AGOZZINO, Mattia

19PA0177

55 kg MILITELLO, Claudio
74 kg MILITELLO, Benito
PIOMBO, Giorgio
TARANTINO, Giovanni
84 kg TARANTINO, Francesco
96 kg DI PACE, Samuele f.

19PA0411

120 kg SANZICA, Pietro giorgio
SIRAGUSA, Ignazio
55 kg NEVES, Kristian
74 kg MARZOUGUI, Mekki
96 kg AMICO, Giuseppe
DI MATTEO, Federico

19PA0639

50 kg AZZARELLO, Marco
55 kg ABBADESSA, Mario
60 kg CALANDRONE, Giuseppe
CHIARA, Massimiliano
66 kg VAZZANA, Alessandro
84 kg CEFALU', Giorgio
96 kg TRAPANI, Stefano



Liste des Engagés par pays / Entry-List By Country

CAMPIONATO ITALIANO JUNIORES SL

STYLE FS

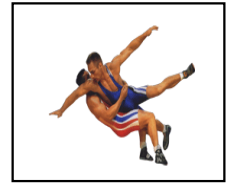

19PA0676

120 kg	ISGRO', Giuseppe
60 kg	MORREALE, Emanuele
74 kg	DUMITRU, Andrei constantin MARINO, Emanuele
96 kg	COTINO, Giovanni STANCANELLI, Fabrizio

19PA0993

55 kg	CHIOVARO, Silvestro
60 kg	CIACIO, Ivan
96 kg	FICALORA, Giuseppe

19PA1543

66 kg	LEONE, Salvatore cristian
-------	---------------------------

20SS0992

74 kg	USAI, Alessandro
-------	------------------



Feuille de compétition / Competition Sheet

CAMPIONATO ITALIANO JUNIORES SL



STYLE : FS 120 kg

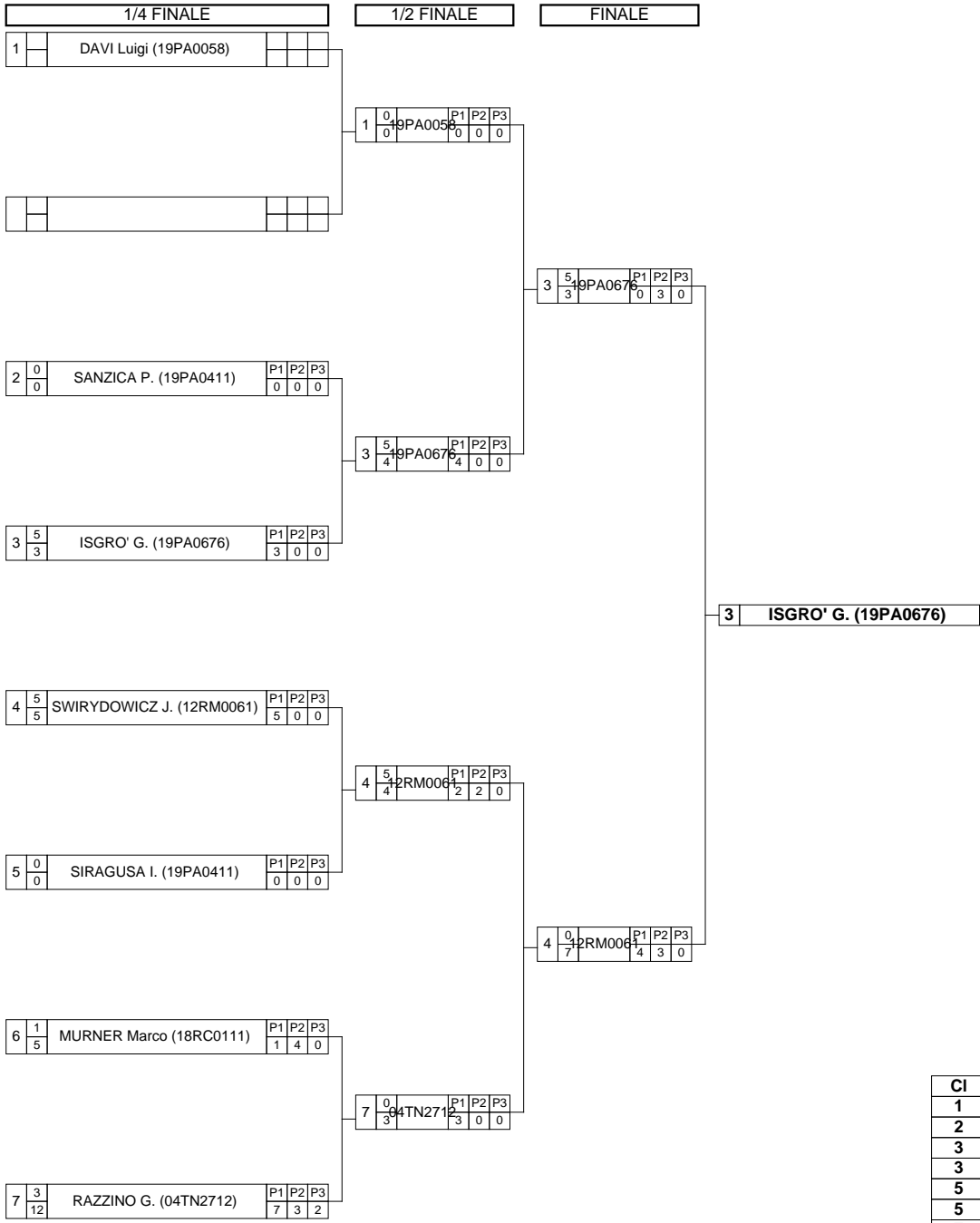

Classement

Cl	Pays	Nom
1	19PA0676	ISGRO' Giuseppe
2	12RM0061	SWIRYDOWICZ Janusz
3	19PA0058	DAVI Luigi
3	19PA0411	SIRAGUSA Ignazio
5	19PA0411	SANZICA Pietro giorgio
5	04TN2712	RAZZINO Gabriele
7	18RC0111	MURNER Marco

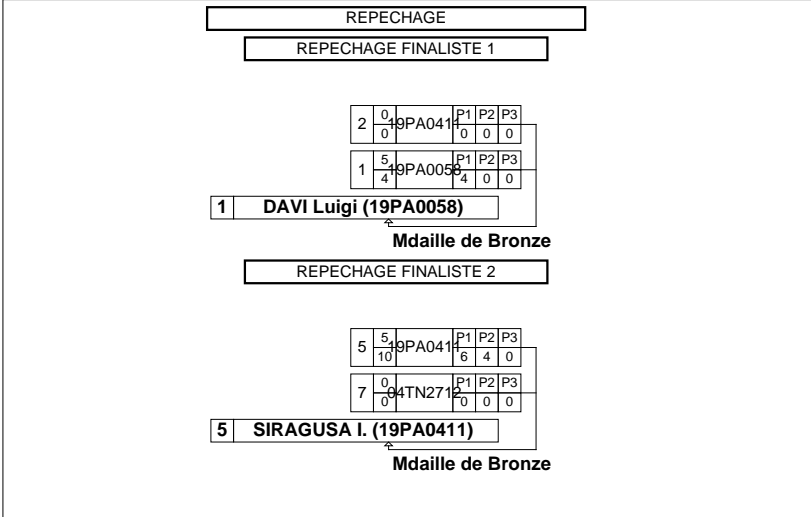



Classement

CAMPIONATO ITALIANO JUNIORES SL

STYLE : FS 120 kg



1 - Or / Gold



ISGRO' Giuseppe

2 - Argent / Silver



SWIRYDOWICZ Janusz

3 - Bronze



DAVI Luigi



SIRAGUSA Ignazio

Classement	Nom - Name	Pays - Country
1	ISGRO' Giuseppe	19PA0676
2	SWIRYDOWICZ Janusz	12RM0061
3	DAVI Luigi	19PA0058
3	SIRAGUSA Ignazio	19PA0411
5	SANZICA P.	19PA0411
5	RAZZINO Gabriele	04TN2712
7	MURNER Marco	18RC0111



Feuille de compétition / Competition Sheet

CAMPIONATO ITALIANO JUNIORES SL

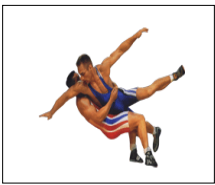

STYLE : FS 50 kg

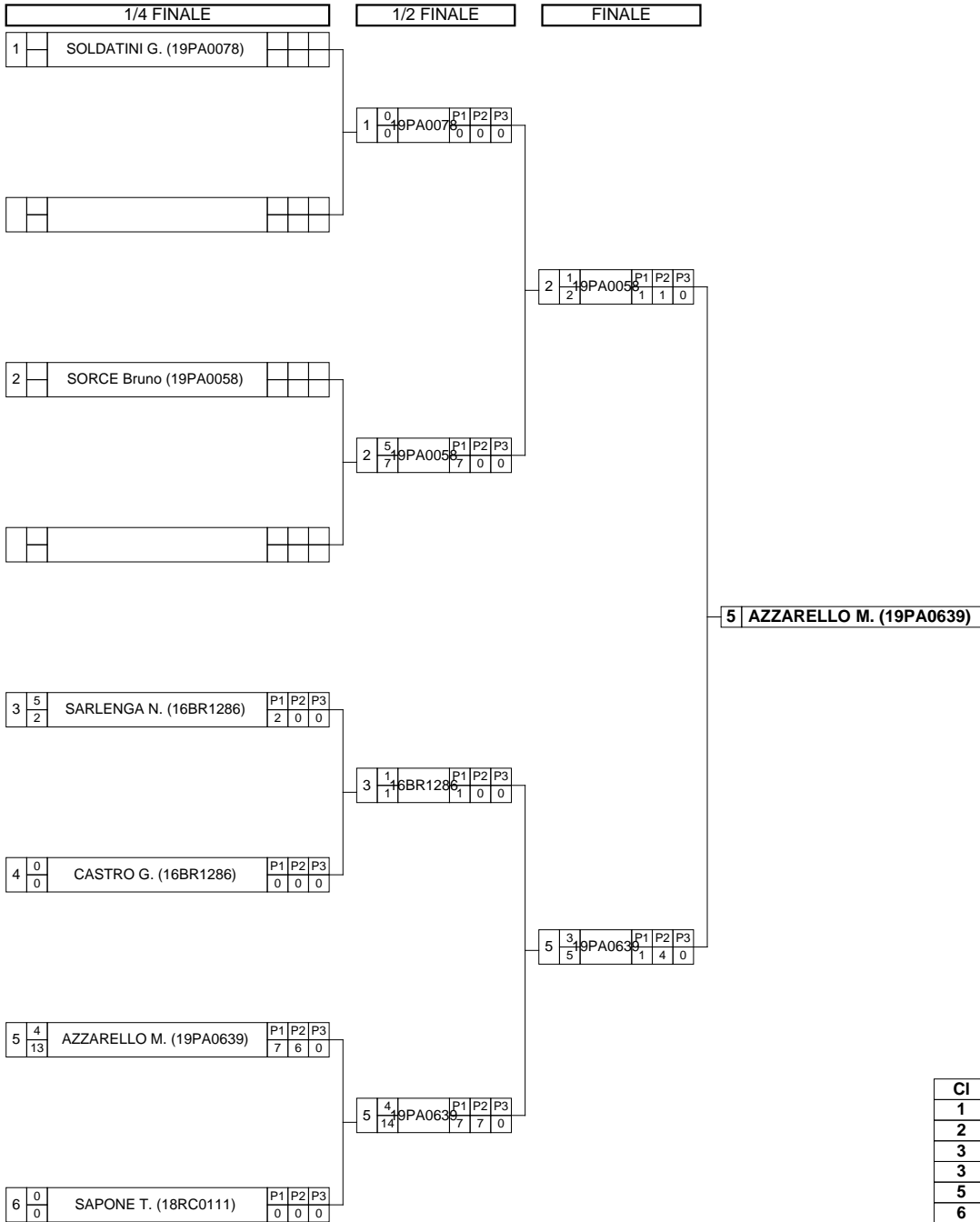

Classement

Cl	Pays	Nom
1	19PA0639	AZZARELLO Marco
2	19PA0058	SORCE Bruno
3	19PA0078	SOLDATINI Giorgio
3	16BR1286	SARLENGA Nunzio
5	18RC0111	SAPONE Tiberio
6	16BR1286	CASTRO Giuseppe

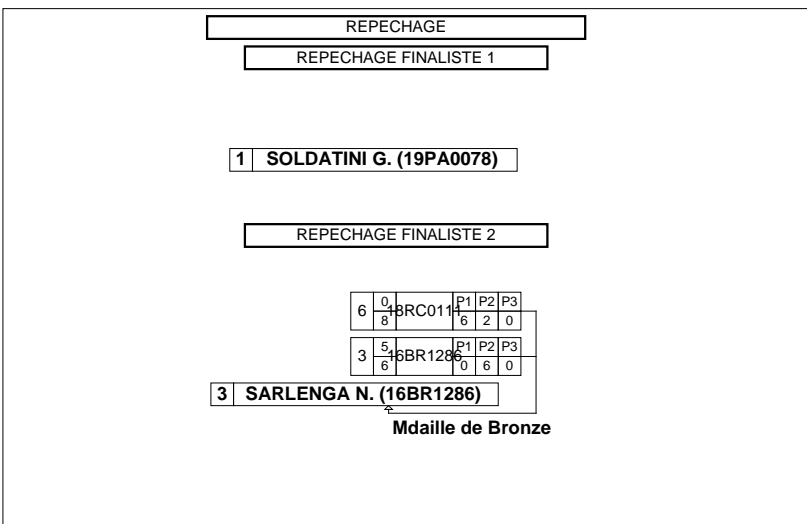



Classement

CAMPIONATO ITALIANO JUNIORES SL

STYLE : FS 50 kg

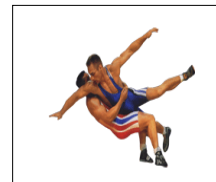

1 - Or / Gold



AZZARELLO Marco

2 - Argent / Silver



SORCE Bruno

3 - Bronze



SOLDATINI Giorgio



SARLENGA Nunzio

Classement	Nom - Name	Pays - Country
1	AZZARELLO Marco	19PA0639
2	SORCE Bruno	19PA0058
3	SOLDATINI Giorgio	19PA0078
3	SARLENGA Nunzio	16BR1286
5	SAPONE Tiberio	18RC0111
6	CASTRO Giuseppe	16BR1286



Feuille de compétition / Competition Sheet

CAMPIONATO ITALIANO JUNIORES SL

STYLE : FS 55 kg

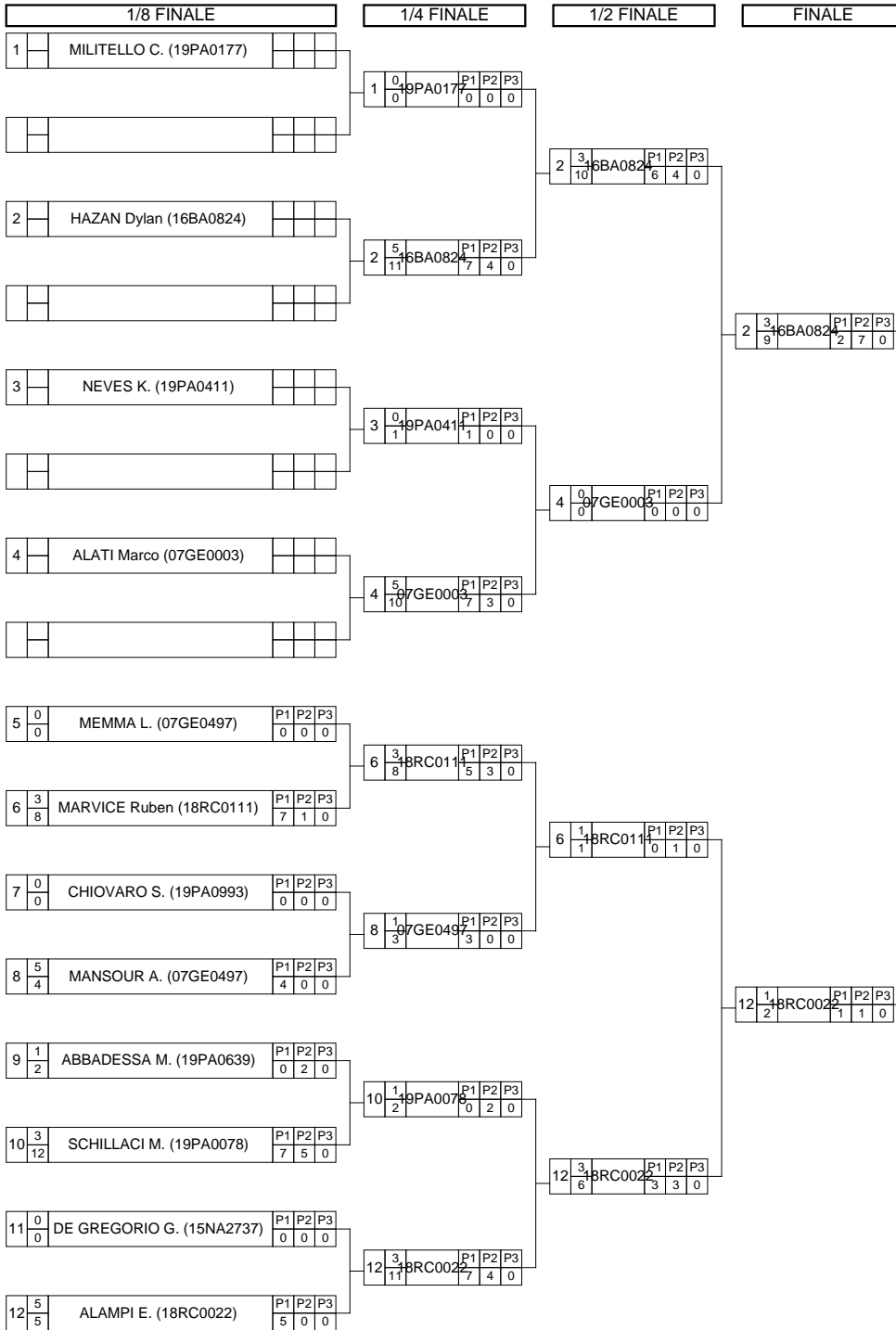

2 HAZAN Dylan (16BA0824)

Classement

Cl	Pays	Nom
1	16BA0824	HAZAN Dylan
2	18RC0022	ALAMPI Emanuele
3	07GE0003	ALATI Marco
3	18RC0111	MARVICE Ruben
5	19PA0177	MILITELLO Claudio
5	15NA2737	DE GREGORIO Girolamo
7	07GE0497	MANSOUR Abdellatif
8	19PA0078	SCHILLACI Marco
9	19PA0639	ABBADESSA Mario
10	19PA0411	NEVES Kristian
11	19PA0993	CHIOVARO Silvestro
12	07GE0497	MEMMA Luca corrado

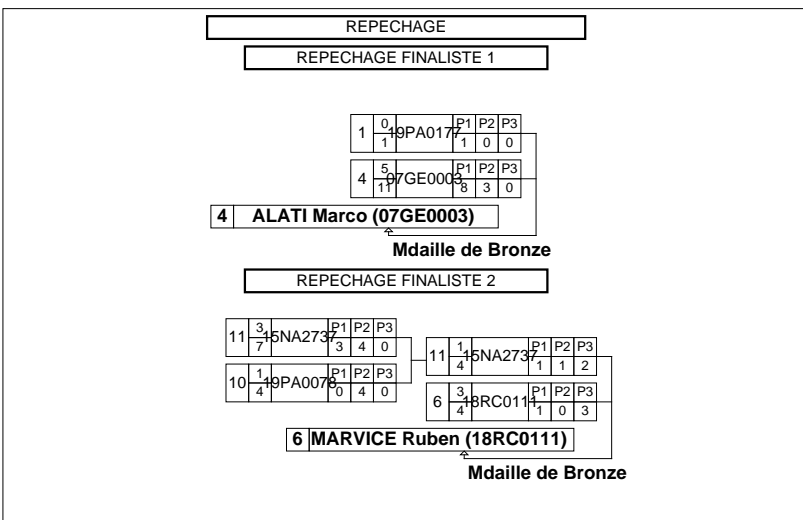



Classement

CAMPIONATO ITALIANO JUNIORES SL

STYLE : FS 55 kg



1 - Or / Gold



HAZAN Dylan

2 - Argent / Silver



ALAMPI Emanuele

3 - Bronze



ALATI Marco



MARVICE Ruben

Classement	Nom - Name	Pays - Country
1	HAZAN Dylan	16BA0824
2	ALAMPI Emanuele	18RC0022
3	ALATI Marco	07GE0003
3	MARVICE Ruben	18RC0111
5	MILITELLO Claudio	19PA0177
5	DE GREGORIO G.	15NA2737
7	MANSOUR Abdellatif	07GE0497
8	SCHILLACI Marco	19PA0078
9	ABBADESSA Mario	19PA0639
10	NEVES Kristian	19PA0411
11	CHIOVARO Silvestro	19PA0993
12	MEMMA Luca corrado	07GE0497



Feuille de compétition / Competition Sheet

CAMPIONATO ITALIANO JUNIORES SL

STYLE : FS 60 kg

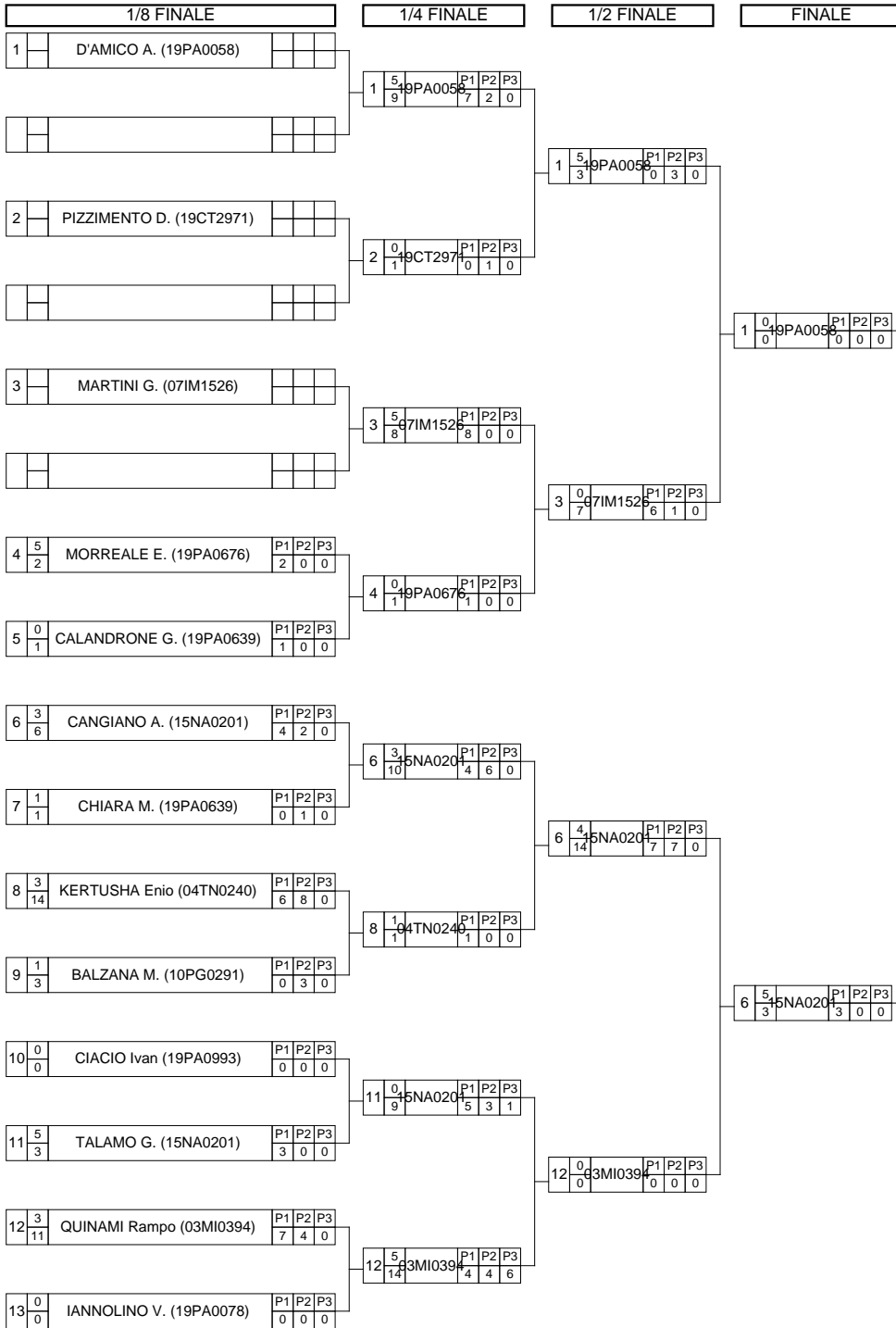

6 CANGIANO A. (15NA0201)

Classement

Cl	Pays	Nom
1	15NA0201	CANGIANO Alessandro
2	19PA0058	D'AMICO Alessandro
3	07IM1526	MARTINI Giacomo
3	04TN0240	KERTUSHA Enio
5	19CT2971	PIZZIMENTO Damiano
5	03MI0394	QUINAMI Rampo
7	15NA0201	TALAMO Gianluca
8	19PA0676	MORREALE Emanuele
9	19PA0639	CHIARA Massimiliano
10	10PG0291	BALZANA Michael
11	19PA0639	CALANDRONE Giuseppe
12	19PA0993	CIACIO Ivan
13	19PA0078	IANNOLINO Vincenzo

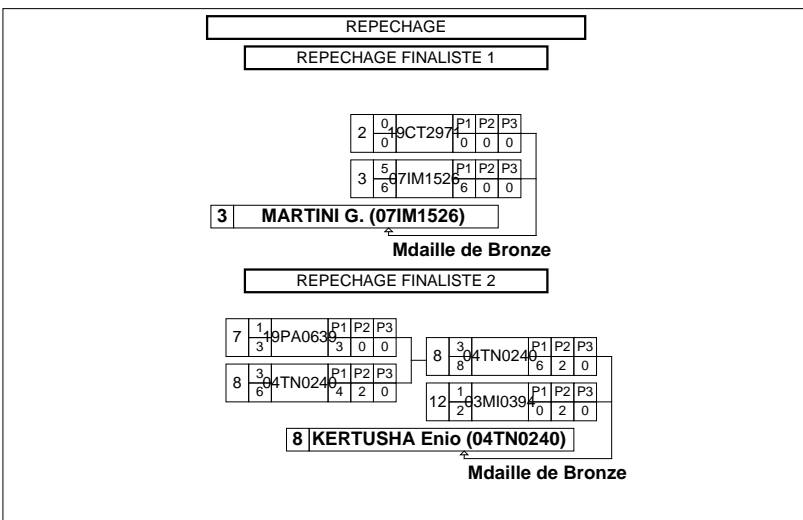



Classement

CAMPIONATO ITALIANO JUNIORES SL

STYLE : FS 60 kg



1 - Or / Gold



CANGIANO Alessandro

2 - Argent / Silver



D'AMICO Alessandro

3 - Bronze



MARTINI Giacomo



KERTUSHA Enio

Classement	Nom - Name	Pays - Country
1	CANGIANO Alessandro	15NA0201
2	D'AMICO Alessandro	19PA0058
3	MARTINI Giacomo	07IM1526
3	KERTUSHA Enio	04TN0240
5	PIZZIMENTO Damiano	19CT2971
5	QUINAMI Rampo	03MI0394
7	TALAMO Gianluca	15NA0201
8	MORREALE Emanuele	19PA0676
9	CHIARA Massimiliano	19PA0639
10	BALZANA Michael	10PG0291
11	CALANDRONE Giuseppe	19PA0639
12	CIACIO Ivan	19PA0993
13	IANNOLINO Vincenzo	19PA0078



Feuille de compétition / Competition Sheet

CAMPIONATO ITALIANO JUNIORES SL

STYLE : FS 66 kg



QUALIFICATION				1/8 FINALE			1/4 FINALE			1/2 FINALE			FINALE		
1	FRAGASCIO L. (19PA0058)			1	3	19PA0058	P1	P2	P3	3	2	0			
2	ANGHELESCU M. (10PG0458)			2	0	10PG0458	P1	P2	P3	0	0	0			
3	MENDIETA G. (19PA0078)			3	3	19PA0078	P1	P2	P3	4	2	0			
4	MELACCA G. (16BR1286)			4	1	16BR1286	P1	P2	P3	0	1	0			
5	COCO Gianluca (19CT2677)			5	3	19CT2677	P1	P2	P3	2	0	1			
6	VAZZANA A. (19PA0639)			6	1	19PA0639	P1	P2	P3	0	2	1			
7	TROIANI Marco (07GE0003)			7	1	07GE0003	P1	P2	P3	0	2	0			
8	VATTIATO F. (19CT2677)			8	3	19CT2677	P1	P2	P3	6	2	0			
9	LABATE Luca (18RC1303)			9	0	18RC1303	P1	P2	P3	0	0	0			
10	CASABURI G. (15NA2737)			10	1	15NA2737	P1	P2	P3	3	0	0			
11	VARRELLA A. (15NA0201)			11	4	15NA0201	P1	P2	P3	7	7	0			
12	GUERRAZZI L. (12RM0061)			12	0	12RM0061	P1	P2	P3	0	0	0			
13	FERRARO G. (18RC0111)			13	0	18RC0111	P1	P2	P3	0	0	0			
14	SPADARO Marco (18RC1303)			14	4	18RC1303	P1	P2	P3	7	6	0			
15	MESSINA A. (19CT2677)			15	0	19CT2677	P1	P2	P3	7	8	0			
16	GUMBERIDZE A. (03MI0394)	P1	P2	P3	4	0	0								
17	LEONE S. (19PA1543)	P1	P2	P3	4	0	0								

5 COCO Gianluca (19CT2677)

Classement

Cl	Pays	Nom
1	19CT2677	COCO Gianluca
2	15NA0201	VARRELLA Antonio giuseppe
3	19PA0639	VAZZANA Alessandro
3	12RM0061	GUERRAZZI Luca
5	19PA0058	FRAGASCIO Luca
5	19PA1543	LEONE Salvatore cristian
7	15NA2737	CASABURI Gaetano
8	18RC1303	SPADARO Marco
9	19CT2677	VATTIATO Francesco
10	19PA0078	MENDIETA Giuseppe
11	07GE0003	TROIANI Marco
12	16BR1286	MELACCA Gabriele
13	19CT2677	MESSINA Alberto
14	03MI0394	GUMBERIDZE Aleksandre
15	10PG0458	ANGHELESCU Marian
16	18RC1303	LABATE Luca
17	18RC0111	FERRARO Giuseppe

REPECHAGE

REPECHAGE FINALISTE 1

6	5	19PA0639	P1	P2	P3	6	3	19PA0639	P1	P2	P3
	3		3	0	0		2		6	6	0
8	0	19CT2677	P1	P2	P3	1	0	19PA0058	P1	P2	P3
	0		0	0	0		0		0	0	0

6 VAZZANA A. (19PA0639)

Mdaille de Bronze

REPECHAGE FINALISTE 2

12	5	12RM0061	P1	P2	P3	12	4	12RM0061	P1	P2	P3
	9		9	0	0		7		6	0	0
10	0	15NA2737	P1	P2	P3	17	0	19PA1543	P1	P2	P3
	0		0	0	0		0		0	0	0

12 GUERRAZZI L. (12RM0061)

Mdaille de Bronze

**Classement****CAMPIONATO ITALIANO JUNIORES SL**

STYLE : FS 66 kg

**1 - Or / Gold**

COCO Gianluca

2 - Argent / Silver

VARRELLA Antonio giuseppe

3 - Bronze

VAZZANA Alessandro



GUERRAZZI Luca

<i>Classement</i>	<i>Nom - Name</i>	<i>Pays - Country</i>
1	COCO Gianluca	19CT2677
2	VARRELLA A.	15NA0201
3	VAZZANA Alessandro	19PA0639
3	GUERRAZZI Luca	12RM0061
5	FRAGASCIO Luca	19PA0058
5	LEONE S.	19PA1543
7	CASABURI Gaetano	15NA2737
8	SPADARO Marco	18RC1303
9	VATTIATO Francesco	19CT2677
10	MENDIETA Giuseppe	19PA0078
11	TROIANI Marco	07GE0003
12	MELACCA Gabriele	16BR1286
13	MESSINA Alberto	19CT2677
14	GUMBERIDZE A.	03MI0394
15	ANGHELESCU Marian	10PG0458
16	LABATE Luca	18RC1303
17	FERRARO Giuseppe	18RC0111



Feuille de compétition / Competition Sheet

CAMPIONATO ITALIANO JUNIORES SL

STYLE : FS 74 kg



QUALIFICATION			1/8 FINALE			1/4 FINALE			1/2 FINALE			FINALE		
1	TRUNCALI M. (12RM1302)		1	5	3	1	0	0	4	3	9	4	1	1
2	MARINO E. (19PA0676)		2	0	0	2	0	0	4	1	1	4	1	1
3	TROMBACCA C. (16BR1286)	P1 P2 P3 0 0 0	4	4	14	4	4	14	4	3	9	4	1	1
4	AGRIGOROSOEI S. (12RM0449)	P1 P2 P3 6 7 0	6	0	0	6	0	0	4	1	1	4	1	1
5	MUSCIANESE B. (18RC0111)	P1 P2 P3 3 0 0	8	0	0	10	1	3	4	1	1	4	1	1
6	ROSATI F. (10TR0030)	P1 P2 P3 5 0 0	10	3	10	10	3	10	4	1	1	4	1	1
7	MARZOGUI M. (19PA0411)	P1 P2 P3 0 0 0	12	1	1	13	3	5	4	1	1	4	1	1
8	TARANTINO G. (19PA0177)	P1 P2 P3 0 0 0	13	3	7	13	3	7	4	1	1	4	1	1
9	MURRI Andrea (12RM1302)	P1 P2 P3 7 0 0	16	5	6	16	5	6	4	1	1	4	1	1
10	BATTISTI A. (10TR0030)	P1 P2 P3 1 0 1	18	0	0	18	0	0	4	1	1	4	1	1
11	JEBALI Josepe (09PI0673)	P1 P2 P3 0 0 0	19	5	2	19	5	2	4	1	1	4	1	1
12	MANZARA F. (12RM0061)	P1 P2 P3 1 1 0	20	0	0	20	0	0	4	1	1	4	1	1
13	MESSINA A. (19CT2677)	P1 P2 P3 2 1 0	21	0	1	21	0	1	4	1	1	4	1	1
14	PETRUK V. (03CO0085)	P1 P2 P3 1 0 0	22	5	7	22	5	7	4	1	1	4	1	1
15	COMBERTI D. (07GE0497)	P1 P2 P3 0 0 0	24	5	8	24	5	8	4	1	1	4	1	1
16	BORDINO F. (19PA0078)	P1 P2 P3 6 6 0	26	0	4	26	0	4	4	1	1	4	1	1
17	CACCAMO M. (18RC1303)	P1 P2 P3 2 0 0	27	4	14	27	4	14	4	1	1	4	1	1
18	PIOMBO G. (19PA0177)	P1 P2 P3 2 0 0	28	0	0	28	0	0	4	1	1	4	1	1
19	PREJBAN Liviu (07GE0003)	P1 P2 P3 2 0 0	29	3	7	29	3	7	4	1	1	4	1	1
20	TOFFANINI V. (07GE0497)	P1 P2 P3 0 0 0	30	1	4	30	1	4	4	1	1	4	1	1
21	TORTOROLO A. (07GE0497)	P1 P2 P3 1 0 0												
22	ENDRIZZI G. (04TN0240)	P1 P2 P3 3 4 0												
23	CANDIDO P. (18RC0111)	P1 P2 P3 2 0 0												
24	USAI A. (20SS0992)	P1 P2 P3 8 0 0												
25	DUMITRU A. (19PA0676)	P1 P2 P3 0 0 0												
26	GIOVANNETTI G. (12RM0061)	P1 P2 P3 4 0 0												
27	CANEVA Aron (07GE0497)	P1 P2 P3 4 0 0												
28	MILITELLO B. (19PA0177)	P1 P2 P3 0 0 0												
29	GALVAGNI G. (04TN0240)	P1 P2 P3 5 2 0												
30	MOSQUERA RUIZ L. (10PG0291)	P1 P2 P3 4 0 0												

27 CANEVA Aron (07GE0497)

Classement

Cl	Pays	Nom
1	07GE0497	CANEVA Aron
2	12RM0449	AGRIGOROSOEI Sebastian Costel
3	19CT2677	MESSINA Alessandro
3	07GE0003	PREJBAN Liviu
5	10TR0030	ROSATI Francesco
5	20SS0992	USAI Alessandro
7	19PA0078	BORDINO Federico
8	04TN0240	GALVAGNI Giacomo
9	10TR0030	BATTISTI Annibale
10	04TN0240	ENDRIZZI Giuseppe
11	12RM1302	TRUNCALI Matteo
12	12RM1302	TRUNCALI Matteo
13	19PA0177	PIOMBO Giorgio
14	19PA0177	TARANTINO Giovanni
15	12RM0061	MANZARA Francesco
16	12RM1302	MURRI Andrea
17	10PG0291	MOSQUERA RUIZ Lenin fernando
18	03CO0085	PETRUK Volodymyr
19	16BR1286	TROMBACCA Cosimo
20	18RC0111	MUSCIANESE Beniamino
21	19PA0177	MILITELLO Benito
22	18RC1303	CACCAMO Michelangelo
23	18RC0111	CANDIDO Pietro
24	07GE0497	TORTOROLO Alessio
25	19PA0411	MARZOGUI Mekki
26	09PI0673	JEBALI Josepe
27	07GE0497	TOFFANINI Vendel
28	19PA0676	MARINO Emanuele
29	19PA0676	DUMITRU Andrei constantin
30	07GE0497	COMBERTI Davide

REPECHAGE

REPECHAGE FINALISTE 1

3	0	16	6	5	0	6	0	0		
	P1	P2	P1	P2	P3		P1	P2	P3	
	0	3		0	0		0	0	0	
6	5	16	1	0	0	13	5	4		
	P1	P2		P1	P2	P3		P1	P2	P3
	5	6		0	0		4	0	0	

13 MESSINA A. (19CT2677)

Mdaille de Bronze

REPECHAGE FINALISTE 2

28	0	3	29	0	0	24	0	0		
	P1	P2		P1	P2	P3		P1	P2	P3
	0	3		0	0		0	0	0	
29	5	13	24	5	8	19	5	4		
	P1	P2		P1	P2	P3		P1	P2	P3
	7	6		4	4		4	0	0	

19 PREJBAN Liviu (07GE0003)

Mdaille de Bronze

**Classement****CAMPIONATO ITALIANO JUNIORES SL**

STYLE : FS 74 kg

**1 - Or / Gold**

CANEVA Aron

2 - Argent / Silver

AGRIGOROSOAEI Sebastian Costel

3 - Bronze

MESSINA Alessandro



PREJBAN Liviu

<i>Classement</i>	<i>Nom - Name</i>	<i>Pays - Country</i>
1	CANEVA Aron	07GE0497
2	AGRIGOROSOAEI S.	12RM0449
3	MESSINA Alessandro	19CT2677
3	PREJBAN Liviu	07GE0003
5	ROSATI Francesco	10TR0030
5	USAI Alessandro	20SS0992
7	BORDINO Federico	19PA0078
8	GALVAGNI Giacomo	04TN0240
9	BATTISTI Annibale	10TR0030
10	ENDRIZZI Giuseppe	04TN0240
11	GIOVANNETTI G.	12RM0061
12	TRUNCALI Matteo	12RM1302
13	PIOMBO Giorgio	19PA0177
14	TARANTINO Giovanni	19PA0177
15	MANZARA Francesco	12RM0061
16	MURRI Andrea	12RM1302
17	MOSQUERA RUIZ L.	10PG0291
18	PETRUK Volodymyr	03CO0085
19	TROMBACCA Cosimo	16BR1286
20	MUSCIANESE B.	18RC0111
21	MILITELLO Benito	19PA0177
22	CACCAMO M.	18RC1303
23	CANDIDO Pietro	18RC0111
24	TORTOROLO Alessio	07GE0497
25	MARZOUGUI Mekki	19PA0411
26	JEBALI Josepe	09PI0673
27	TOFFANINI Vendel	07GE0497
28	MARINO Emanuele	19PA0676
29	DUMITRU A.	19PA0676
30	COMBERTI Davide	07GE0497



Feuille de compétition / Competition Sheet

CAMPIONATO ITALIANO JUNIORES SL

STYLE : FS 84 kg

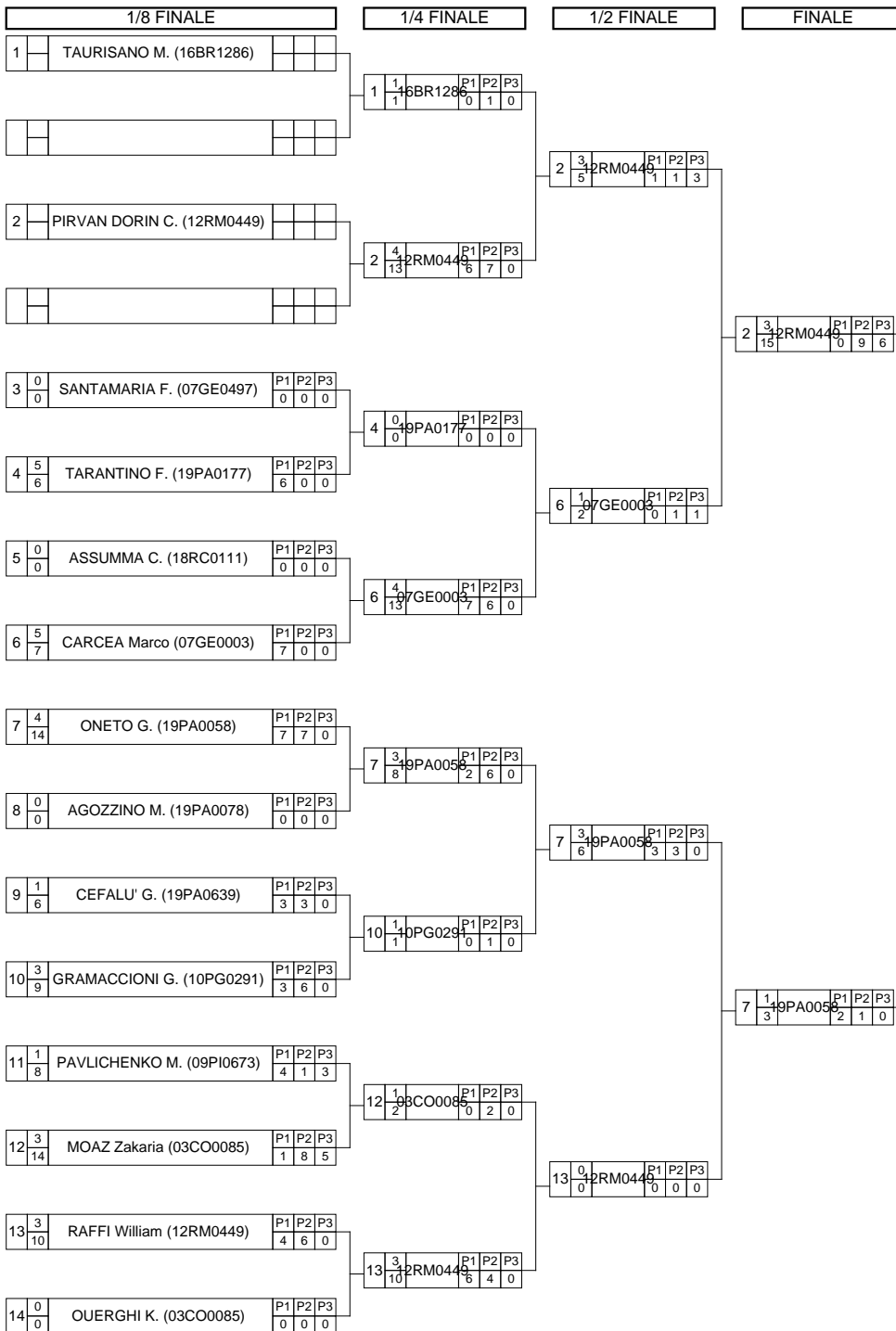

2 PIRVAN DORIN C. (12RM0449)

Classement

Cl	Pays	Nom
1	12RM0449	PIRVAN DORIN Costantin
2	19PA0058	ONETO Gabriele
3	07GE0003	CARCEA Marco
3	12RM0449	RAFFI William
5	16BR1286	TAURISANO Marco
5	10PG0291	GRAMACCIONI Giacomo
7	19PA0177	TARANTINO Francesco
8	03CO0085	MOAZ Zakaria
9	09PI0673	PAVLICHENKO Mark
10	19PA0639	CEFALU' Giorgio
11	07GE0497	SANTAMARIA Francesco
12	18RC0111	ASSUMMA Carmelo
13	03CO0085	OUERGHY Khalil
14	19PA0078	AGOZZINO Mattia

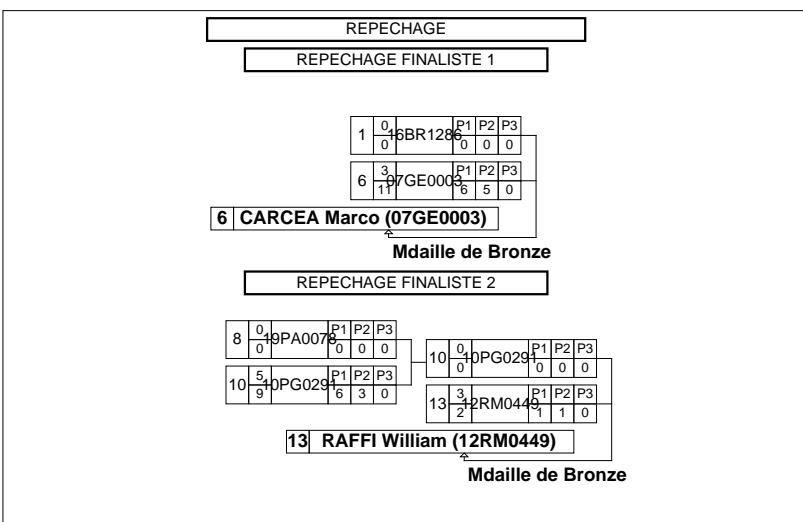



Classement

CAMPIONATO ITALIANO JUNIORES SL

STYLE : FS 84 kg



1 - Or / Gold



PIRVAN DORIN Costantin

2 - Argent / Silver



ONETO Gabriele

3 - Bronze



CARCEA Marco



RAFFI William

Classement	Nom - Name	Pays - Country
1	PIRVAN DORIN C.	12RM0449
2	ONETO Gabriele	19PA0058
3	CARCEA Marco	07GE0003
3	RAFFI William	12RM0449
5	TAURISANO Marco	16BR1286
5	GRAMACCIONI Giacomo	10PG0291
7	TARANTINO Francesco	19PA0177
8	MOAZ Zakaria	03CO0085
9	PAVLICHENKO Mark	09PI0673
10	CEFALU' Giorgio	19PA0639
11	SANTAMARIA F.	07GE0497
12	ASSUMMA Carmelo	18RC0111
13	OUERGHI Khalil	03CO0085
14	AGOZZINO Mattia	19PA0078



Feuille de compétition / Competition Sheet

CAMPIONATO ITALIANO JUNIORES SL

STYLE : FS 96 kg

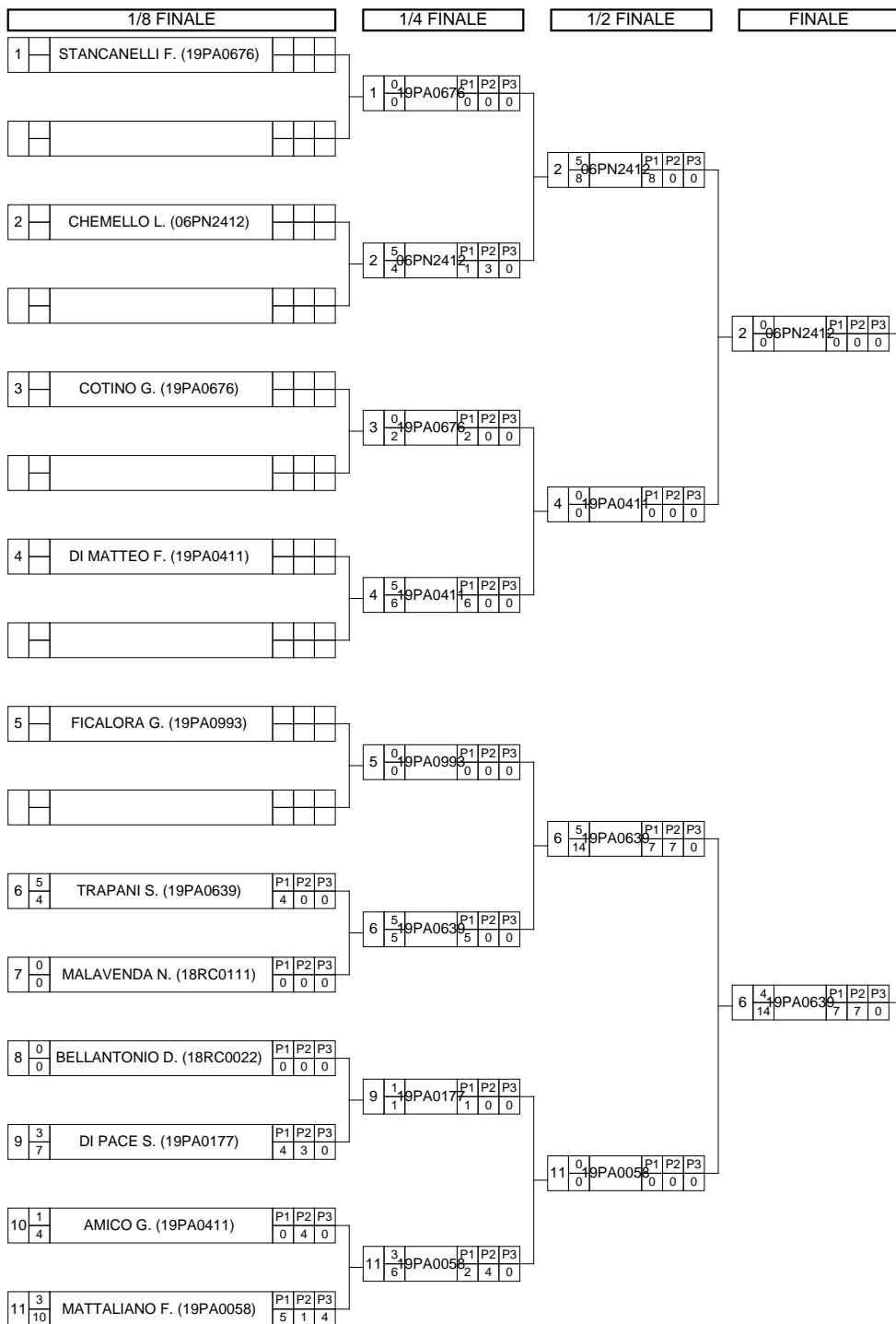

6 TRAPANI S. (19PA0639)

Classement

Cl	Pays	Nom
1	19PA0639	TRAPANI Stefano
2	06PN2412	CHEMELLO Loris
3	19PA0411	DI MATTEO Federico
3	19PA0058	MATTALIANO Francesco
5	18RC0111	MALAVENDA Natale
5	19PA0676	STANCANELLI Fabrizio
7	19PA0177	DI PACE Samuele f.
8	19PA0993	FICALORA Giuseppe
9	19PA0411	AMICO Giuseppe
10	19PA0676	COTINO Giovanni
11	18RC0022	BELLANTONIO Domenico

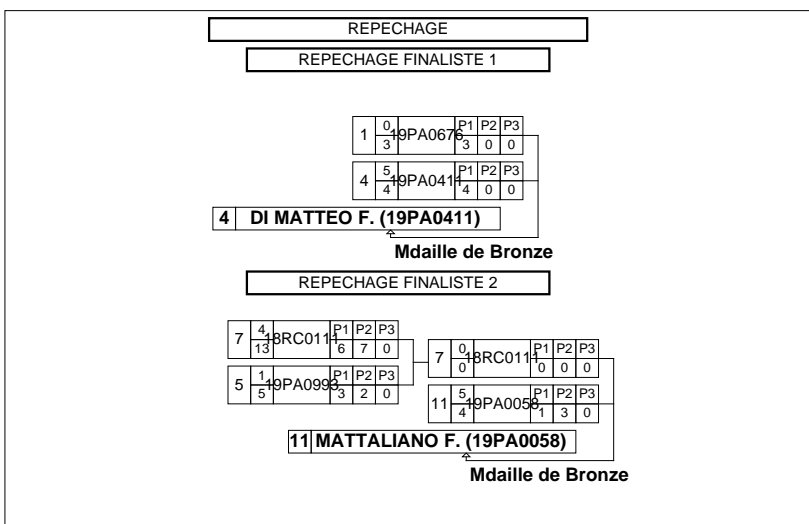



Classement

CAMPIONATO ITALIANO JUNIORES SL

STYLE : FS 96 kg



1 - Or / Gold



TRAPANI Stefano

2 - Argent / Silver



CHEMELLO Loris

3 - Bronze



DI MATTEO Federico



MATTALIANO Francesco

Classement	Nom - Name	Pays - Country
1	TRAPANI Stefano	19PA0639
2	CHEMELLO Loris	06PN2412
3	DI MATTEO Federico	19PA0411
3	MATTALIANO F.	19PA0058
5	MALAVENDA Natale	18RC0111
5	STANCANELLI F.	19PA0676
7	DI PACE Samuele f.	19PA0177
8	FICALORA Giuseppe	19PA0993
9	AMICO Giuseppe	19PA0411
10	COTINO Giovanni	19PA0676
11	BELLANTONIO D.	18RC0022

**Classement par équipe / Teams ranking****CAMPIONATO ITALIANO JUNIORES SL**

STYLE FS



Rang	Equipe	120 KG	50 KG	55 KG	60 KG	66 KG	74 KG	84 KG	96 KG	TOTAL
1	19PA00 58	6	8		8	4		8	6	40
2	19PA06 39		10	1	2	6		1	10	30
3	12RM04 49						8	16		24
4	15NA02 01				12	8				20
5	18RC01 11	2	4	6		1	2	1	4	20
6	07GE00 03			6		1	6	6		19
7	19PA04 11	10		1			1		7	19
8	19CT26 77					12	6			18
9	19PA06 76	10			1		2		5	18
10	07GE04 97			3			13	1		17
11	12RM00 61	8				6	2			16
12	16BR12 86		10			1	1	4		16
13	19PA00 78		6	1	1	1	2	1		12
14	19PA01 77			4			3	2	2	11
15	16BA08 24			10						10
16	18RC00 22			8					1	9
17	06PN24 12								8	8
18	04TN02 40				6		2			8

**Classement par équipe / Teams ranking****CAMPIONATO ITALIANO JUNIORES SL**

STYLE ES

Rang	Equipe	120 KG	50 KG	55 KG	60 KG	66 KG	74 KG	84 KG	96 KG	TOTAL
19	07IM15 26				6					6
20	15NA27 37			4		2				6
21	10PG02 91				1		1	4		6
22	03MI03 94				4	1				5
23	10TR00 30						5			5
24	04TN27 12	4								4
25	19CT29 71				4					4
26	19PA15 43					4				4
27	20SS09 92						4			4
28	03CO00 85						1	2		3
29	18RC13 03					2	1			3
30	19PA09 93			1	1				1	3
31	09PI067 3						1	1		2
32	12RM13 02						2			2
33	10PG04 58					1				1